

Ultra-elegant Gigabit IP Phone

SIP-T48G



Quick Start Guide (V73.40)

Packaging Contents

The following items are included in your package. If you find anything missing, contact your system administrator.

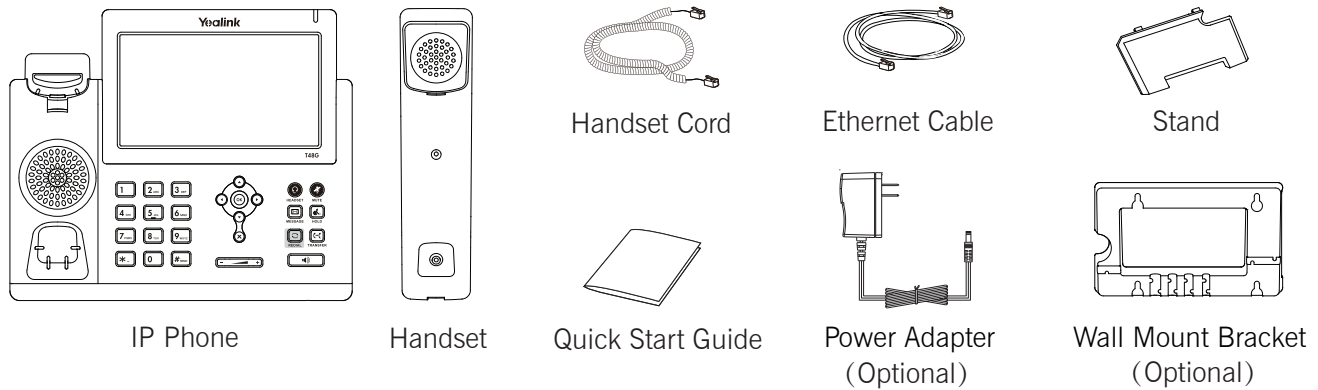

Assembling the Phone

1. Attach the stand, as shown below:

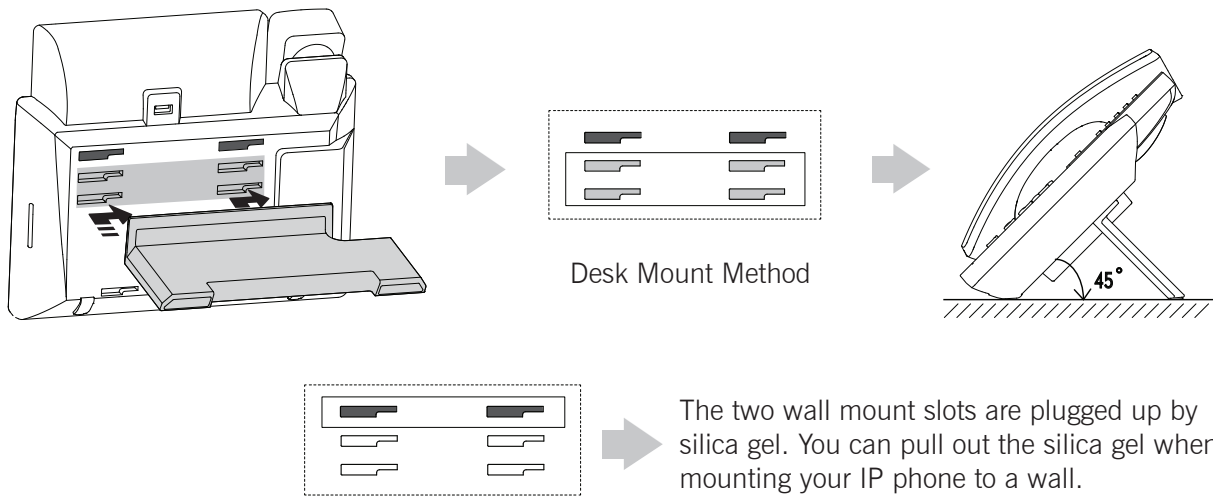

Note: For more information on how to mount the IP phone to a wall, refer to Yealink Wall Mount Quick Installation Guide for SIP-T4X IP Phones.

2. Connect the handset and optional headset, as shown below:

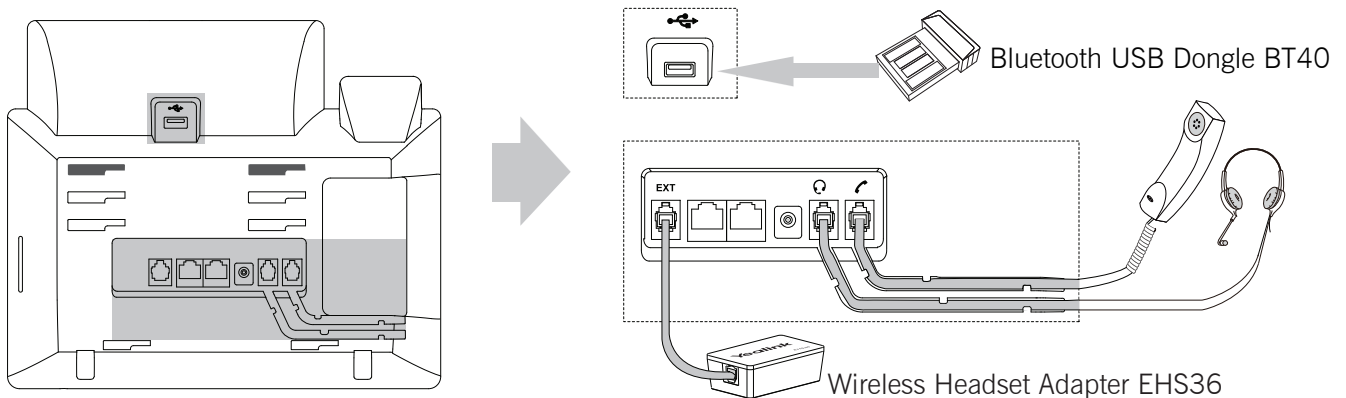

Note: The headset, Bluetooth USB dongle BT40 and wireless headset adapter EHS36 should be purchased separately. The EXT port can also be used to connect the expansion module EXP40. For more information on how to use the EHS36, EXP40 and BT40, refer to Yealink EHS36 User Guide, Yealink EXP40 User Guide and Yealink Bluetooth USB Dongle BT40 User Guide.

3. Connect the network and power, as shown below :

You have two options for network and power connections. Your system administrator will advise you on which one to use.

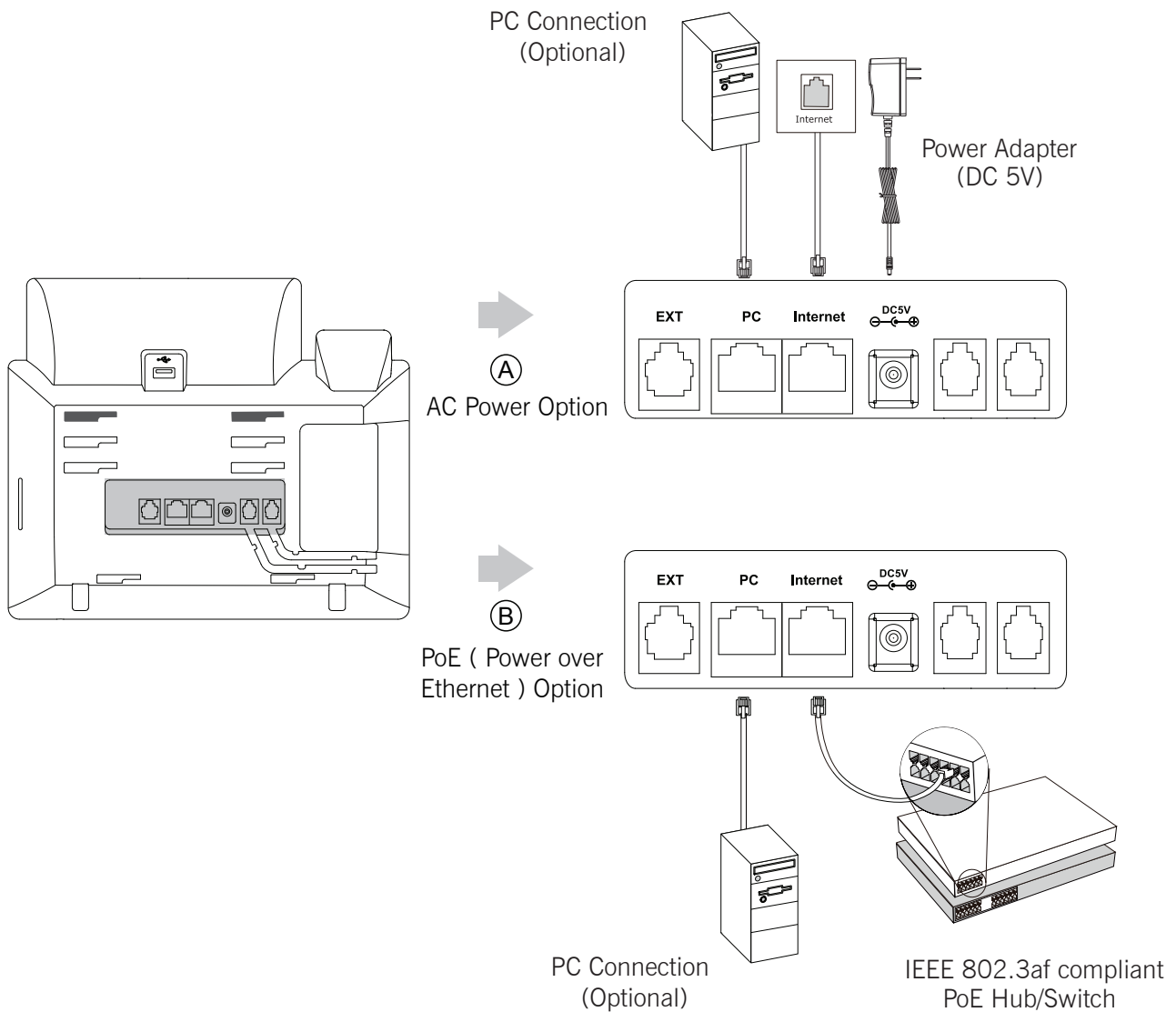

Note: If inline power (PoE) is provided, you don't need to connect the power adapter. Make sure the hub/switch is PoE-compliant.

Startup

After the IP phone is connected to the network and supplied with power, it automatically begins the initialization process. After startup, the phone is ready for use. You can configure the phone via phone user interface or web user interface.

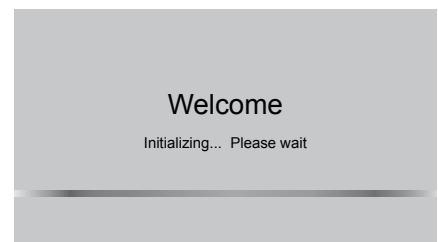

Configuring Your Phone

Configuring via web user interface

Accessing the web user interface:

1. Press the **OK** key when the phone is idle to get the IP address of the phone.
2. Open the web browser of your computer, enter the IP address into the address bar (e.g., "http://192.168.0.10" or "192.168.0.10"), and then press the **Enter**.
3. Enter the user name (default: admin) and password (default: admin) in the login page and click **Confirm**.

Network Settings: Click on **Network->Basic->IPv4 Config**

You can configure the network settings in the following ways:

DHCP: By default, the phone attempts to contact a DHCP server in your network to obtain its valid network settings, e.g., IP address, subnet mask, gateway address and DNS address.

Static IP Address: If your phone can not contact a DHCP server for any reason, you need to configure the IP address subnet mask, gateway address, primary DNS address and secondary DNS address for the phone manually.

PPPoE: If you are using an xDSL modem, you can connect your phone to the Internet via PPPoE mode. Contact the ITSP for the PPPoE user name and password.

Note: The IP phone also supports IPv6, but IPv6 is disabled by default. The wrong network settings may result in inaccessibility of your phone and may have an impact on the network performance. Contact your system administrator for more information.

Account Settings: Click on **Account->Register->Account X (X=1,2,3...15,16)**

Parameters of the account:

Register Status:	It shows the register status of the current account.
Line Active:	You can select Enabled/Disabled to enable/disable the account.
Label:	It is shown on the touch screen to identify the account.
Display Name:	It is shown as Caller ID when placing a call.
Register Name:	It is authenticated ID for authentication provided by ITSP (required).
User Name:	It is provided by ITSP for registration (required).
Password:	It is provided by ITSP for registration (required).
Server Host:	It is provided by ITSP for registration (required).

Register status icons on the touch screen:

 (Green) Registered

 (Gray) Register Failed

 (Green and Flashing) Registering

Note: Check with your system administrator if any error appears during the registration process or if a specific configuration is required for your registration.

Configuring via phone user interface

Network Settings:

When the phone is idle, tap  -> **Advanced Setting** (default password: admin)-> **Network->WAN Port/VLAN/Web Server/802.1x/VPN/LLDP** to configure the network.







Account Settings:

When the phone is idle, tap  -> **Advanced Setting** (default password: admin)-> **Accounts** to configure the account.

Note: For more information on account parameters, refer to **Configuring via web user interface**.

Using Your Phone

Navigating the Touch Screen

- To enter the main menu, tap .
- To return to the idle screen, tap .
- To go back to the previous menu, tap .
- To select a soft key, tap the soft key.
- To select an item, tap the item.
- To turn pages, tap  or  on the touch screen.
- To scroll through values in a pull-down list, press  or .

Entering and Updating Data

To enter data:

1. Tap the field you want to edit.
2. Tap the **IME** soft key to switch input modes.
3. Enter data using the keypad.
4. Tap the **Save** soft key.

To select a field option:

Tap the field name, and then tap the field's highlighted box. From the pull-down list, tap the desired option.

Basic Call Features

Placing a Call

Using the handset:

1. Pick up the handset.
2. Enter the number, and then tap the **Send** soft key.

Using the speakerphone:

1. With the handset on-hook, press .
2. Enter the number, and then tap the **Send** soft key.

Using the headset:

1. With the headset connected, press  to activate the headset mode.
2. Enter the number, and then tap the **Send** soft key.

Note: During a call, you can alternate between the headset, hands-free speakerphone and handset modes by pressing the **HEADSET** key, the **Speakerphone** key or by picking up the handset. Headset mode requires a connected headset.

Answering a Call

Using the handset:

Pick up the handset.

Using the speakerphone:

Press .

Using the headset:

Press .

Note: You can reject an incoming call by tapping the **Reject** soft key.

Ending a Call

Using the handset:

Hang up the handset or tap the **End Call** soft key.



Using the speakerphone:

Press  or tap the **End Call** soft key.



Using the headset:

Tap the **End Call** soft key.

Redial

- Press  to enter the **Placed calls** list, and then tap the desired entry.
- Press  twice when the phone is idle to dial out the last dialed number.

Call Mute and Un-mute



- Press  to mute the microphone during a call.
- Press  again to un-mute the call.

Call Hold and Resume

To place a call on hold:

Press  or tap the **Hold** soft key during an active call.



To resume the call, do one of the following:

- If there is only one call on hold, press  or tap the **Resume** soft key.
- If there is more than one call on hold, tap the call you want to resume, and then press  or tap the **Resume** soft key.



Call Transfer

You can transfer a call in the following ways:



Blind Transfer

1. Press  or tap the **Transfer** soft key during an active call. The call is placed on hold.
2. Enter the number you want to transfer to.
3. Press  or tap the **Transfer** soft key.

Semi-Attended Transfer

1. Press  or tap the **Transfer** soft key during an active call. The call is placed on hold.
2. Enter the number you want to transfer to, and then press  .
3. Press  or tap the **Transfer** soft key when you hear the ring-back tone.

Attended Transfer

1. Press  or tap the **Transfer** soft key during an active call. The call is placed on hold.
2. Enter the number you want to transfer to, and then press  .
3. Press  or tap the **Transfer** soft key when the second party answers.

Call Forward

To enable call forward:

1. When the phone is idle, tap  -> **Features**-> **Call Forward**.
2. Select the desired forward type:
 - Always Forward**----Incoming calls are forwarded unconditionally.
 - Busy Forward**----Incoming calls are forwarded when the phone is busy.
 - No Answer Forward**----Incoming calls are forwarded if not answered after a period of time.
3. Enter the number you want to forward to. For **No Answer Forward**, tap the pull-down list of **After Ring Time**, and then tap the desired ring time to wait before forwarding from the **After Ring Time** field.
4. Tap the **Save** soft key to accept the change.

Call Conference

1. Tap the **Conference** soft key during an active call. The call is placed on hold.



2. Enter the number of the second party, and then tap the **Send** soft key.
3. Tap the **Conference** soft key again when the second party answers. All parties are now joined in the conference.
4. Tap the **End Call** soft key to disconnect all parties.

Note: You can split the conference call into two individual calls by tapping the **Split** soft key.

Voice Message







Message waiting indicator on the idle screen indicates that one or more voice messages are waiting at the message center. The power indicator LED slowly flashes red.

To listen to voice messages(Ensure the voice mail code is already configured on the phone):

1. Tap  and then tap the **Connect** soft key, or press .
2. Follow the voice prompts to listen to your voice messages.

Customizing Your Phone

Call History



1. When the phone is idle, tap , and then tap the desired call list on the left.
2. Tap  or , or press  or  to scroll to the desired page.
3. Tap  after the desired entry, and then you can do the following:
 - Tap **Send** to call the entry.
 - Tap **Add** to add the entry to the local directory.
 - Tap **Edit** to edit the phone number of the entry before placing a call.
 - Tap **Blacklist** to add the entry to the blacklist.
 - Tap **Delete** to delete the entry from the list.

Contact Directory



To add a contact:

1. When the phone is idle, tap , and then tap the desired group on the left.
2. Tap **Add** to add a contact.
3. Enter a unique contact name in the **Name** field and contact numbers in the corresponding fields.
4. Tap the **Save** soft key to accept the change.

To edit a contact:



1. When the phone is idle, tap , and then tap the desired group on the left.
2. Tap  after the desired contact.
3. Edit the contact information.
4. Tap the **Save** soft key to accept the change.

To delete a contact:

1. When the phone is idle, tap , and then tap the desired group on the left.
2. Tap  after the desired contact, and then tap **Delete**.
3. Tap the **OK** soft key when the touch screen prompts "Delete the selected contact?".

Note: You can add contacts from call history easily. For more information, refer to **Call History** above.

Volume Adjustment

- Press  during a call to adjust the receiver volume of the handset/speakerphone/headset.
- Press  when the phone is idle to adjust the ringer volume.

About us

Founded in 2001, Yealink, the global TOP 3 SIP phone provider and a leading provider of VoIP Phone and IP communication solutions, has been focusing on VoIP products characterized by reliable quality, easy deployment and affordable price for more than a decade. Today, customers from over 140 countries rely on Yealink as the backbone of global collaboration to extend the value of network communications.

More about Yealink

Since 2001, Yealink has continued to develop state-of-the art, hi-tech VoIP communication terminals that include IP video phones, IP phones and USB phones. With a worldwide market in more than 140 countries, the company has also established a first-class international service network.

Our priorities are quality, functionality, ease-of-use, customer support and competitive pricing. To provide new solutions for the future in this fast-evolving sector, Yealink's large, talented and highly-experienced VoIP R&D team is totally committed to the pursuit of excellence.

To date, we have passed more than 80 interoperability tests and meet certification requirements set by leading VoIP system and platforms. Yealink works in close partnership with T-Mobile, Telefonica, Portugal Telecom and other leading telecommunication service providers.

